



Pavers



"The paving design of a project has a strong influence on the project's character, its coherence, and, ultimately, on its meaning. A pavement can facilitate connections between the parts of a built environment, and to the person using that space."

- Barbara Lien



At VYARA, we are dedicated to achieving business goals ethically, fostering mutual respect, and creating lasting value. Our products are crafted with technical expertise and precision to elevate the user's experience and enhance every space they touch.

With a steadfast commitment to sustainability, we lead the industry with eco-friendly innovations, including our **GreenPro certified products** and low-carbon solutions like the UNCARBON range. Our cutting-edge offerings—Vacuum Wet Pressed Kerbs for intricate details, the Melange series, EcoPave, Flagstones and Cobbles—stand among the finest in the world, delivering unmatched quality and environmental responsibility.

Index

HSF	High Performance High Strength High Finish Paving	3
EcoPave	Eco-Friendly Grass Paving Solutions	13
Cobbles	Classic Small Cobble Paving	17
MaxiPave	Flag Paving for Pedestrian and Cycling Areas	25
Escalon	Modular Stone Paving Planks	27
Decastone	Modular Paving Set with Ten Stones	29
Decastone Neo	Modular Paving Set with Ten Enhanced Stones	31
Rustico	Modular Paving with Integrated Spacers	33
Beganit Neo	Modular Paving Set with Chamfer-Free Seven Stones	35
Mélange	Colour Blended Concrete Paving Solutions	37
Paver Finishes	Shotblasted, PremierShield and Rustic Options	41
Flagstones	Large Paving Stones of 300*300 mm & Above	43
Bellezza	Elegant Wet Cast Paving Range	49
Kerbstones	International Kerb Solutions & Accessories	53
Etcetera	Diverse Supplementary Products	56
Hollow & Solid Blocks	Versatile Concrete Building Blocks	57
Other Range	Additional VYARA Product Range	58
Design Enhancement	Adding Value Through Design Expertise	59
About Us	Discover VYARA's Legacy	61

VYARA offers a palette of over 50 meticulously curated colour shades from our exclusive colour 'master.' Custom shades can also be tailored to meet specific design preferences upon request.

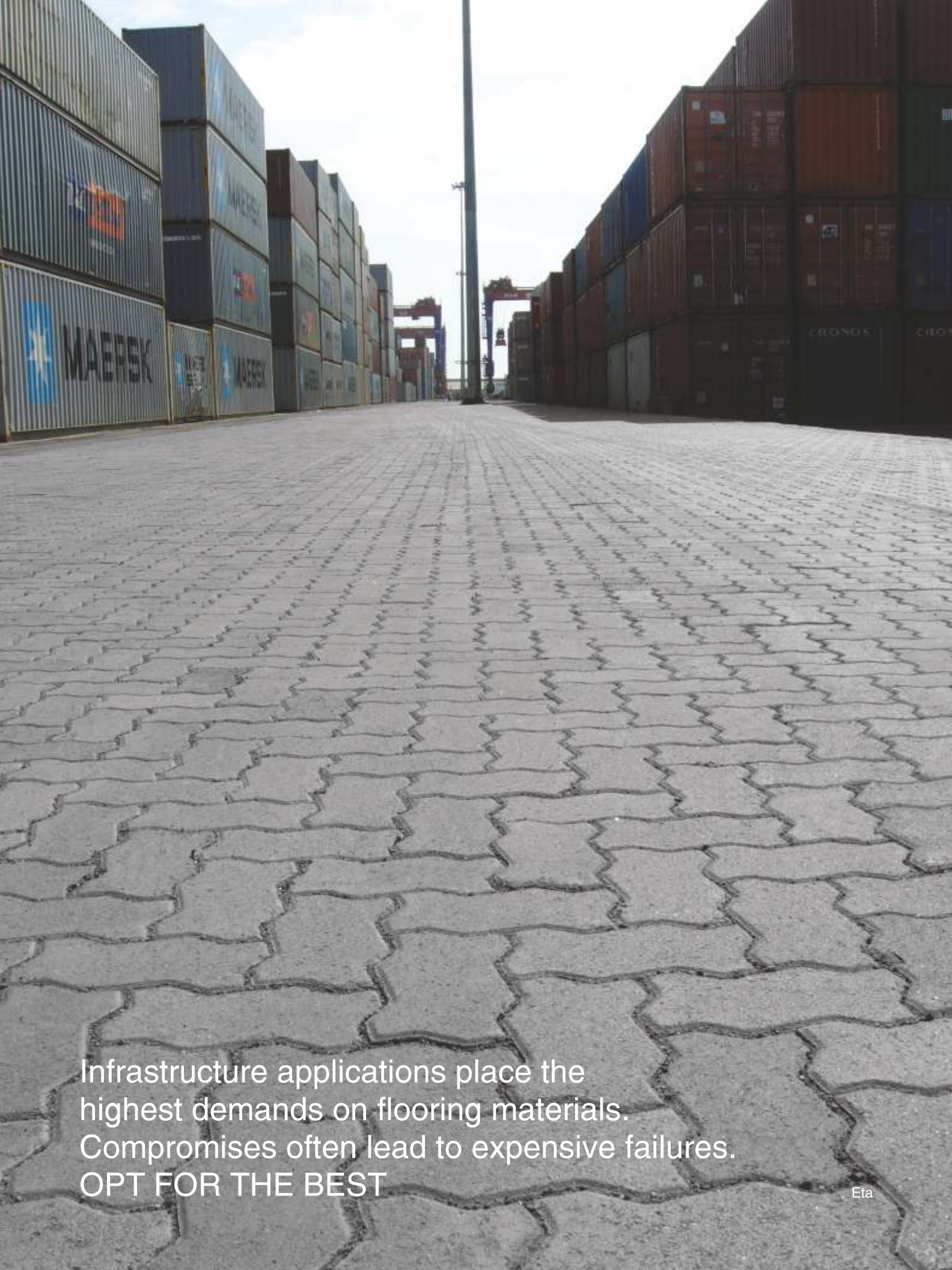

HSF

VYARA's High Strength High Finish (HSF) concrete pavers embody a legacy of reliability, delivering exceptional quality and performance for large-scale, high-stakes projects.

HSF enables you to meet demanding timelines with uncompromised aesthetics and durability, all while boasting one of the lowest carbon footprints in the industry.

Customizable colours and finishes, including Shotblasting and **PremierShield** protection are available to further enhance pavements and spaces.

Infrastructure applications place the highest demands on flooring materials. Compromises often lead to expensive failures. **OPT FOR THE BEST**

Eta



Eta
120/100/80/60 mm



Trihex
80/60 mm



Trihex Grooves
80/60 mm



HSF

VYARA's **Brick** Pavers, in the classic 200x100 mm rectangular shape, offers timeless elegance and clean, versatile lines. They allow precise architectural detailing, adding sophistication to any space.

VYARA's **BrickLine** in a slim 240x60 mm size, combine versatility and refined aesthetics with dynamic pattern options like herringbone and radial layouts.

They are ideal for driveways, walkways, courtyards, and urban landscapes, providing durable and stylish solutions.



Brick
100/80/60 mm



BrickLine Plain
80 mm



BrickLine Stone
80 mm



HSF

The **Square** paving stone is a timeless and versatile choice, favoured by designers for its aesthetic appeal and adaptability. Offered in various sizes and thicknesses, it has been featured in landmark projects like the iconic **Statue of Unity** and Ahmedabad's **C.G. Road**, among many others.

Our **Equilatero** paving stone, originally custom-designed for **Carter Road Promenade, Bandra** offers endless design possibilities. Suitable for pedestrian use and light vehicular traffic, it blends elegance with practicality. Whether your vision leans toward classic charm or contemporary flair, our Square and Equilatero paving stones deliver exceptional results every time.



Square
200*200*80/60 mm | 150*150*80/60 mm



Equilatero
60 mm

Square



Quadrastein Stone

HSF

VYARA's **Quadrastein** paving stone, the first of its kind in India, redefines square paving with innovative wide spacer locks for superior interlocking. Its timeless stone effect, combined with a compact 60 mm size, delivers exceptional durability, often replacing traditional 80 mm pavers without compromising strength.

Designed for heavy-duty applications, landscapes, pedestrian areas, and urban projects, Quadrastein seamlessly blends classic aesthetics with cost-effective performance.



Quadrastein Plain
80/60 mm



Quadrastein Stone
80/60 mm



HSF

The **Strada** comes in a fixed module but allows versatile patterns, exciting color combinations and rustic or shot-blasted finishes.

VYARA's **Behaton**, also known as the I-Shape or Dumbbell Paver, is an iconic interlocking design. Its strength and stability make it ideal for landscapes, industrial areas, and heavy duty applications. Durable and resistant to shifting, it is the go-to choice for robust, long lasting pavements.



Strada
80/60 mm



Behaton
80/60 mm

Strada



ECOPAWE



VYARA's EcoPave range offers sustainable paving solutions that enhance biodiversity and reduce environmental impact.

Choose from a stunning range of VYARA's EcoPave for durability, aesthetics, and environmental responsibility.

Verde, Cubist and Grasline are suitable for vehicular traffic and fire tender loads, making them ideal for car parks and fire access areas.



Verde
330*330*120 mm



Cubist
450*300*120 mm



Grid Paver
600*400*75 mm

Verde



ECOPAVE

EcoPave offers a continuously growing range of decorative grass paving options.

Features of VYARA's EcoPave range are as follows:

- Grass-filled cavities reduce heat islands and create greener spaces.
- Uses recycled materials to lower carbon footprint.
- Reduces and cleans water runoff, aiding aquifer recharge.
- Durable for light traffic and fire brigade loads.
- Supports IGBC and LEED certifications.

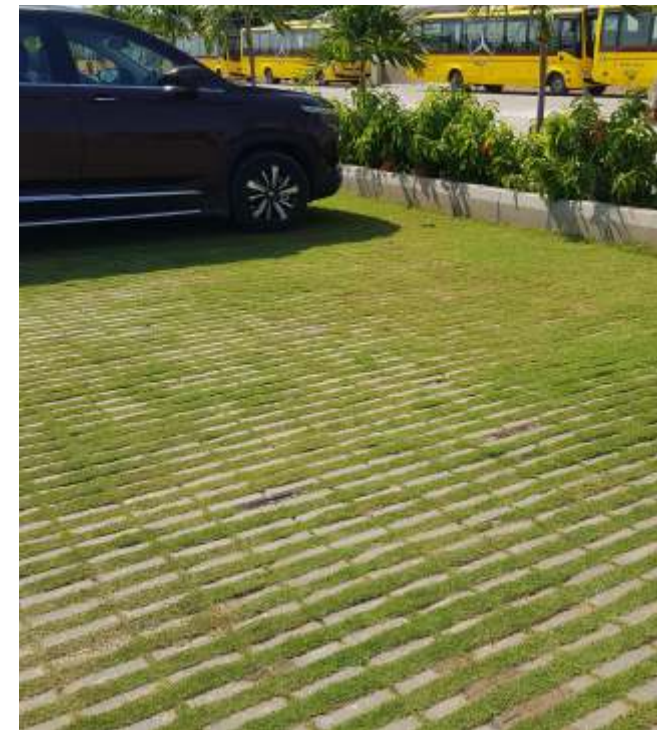

Grasline
200*200*80 mm



Turf
250*250*80/60 mm



COBBLE SQUARE

VYARA's Cobble Square offers a timeless and durable alternative to natural stone cobbles. These 100x100 mm square cobbles feature a clean, modern look and are user-friendly for wheelchairs, the elderly, children and stiletto wearers.

They can be laid in straight lines, staggered joints, or radial patterns beyond a 1-meter radius, adding versatility and visual appeal to residential and commercial hardscapes.

Available in Mélange, Shotblasted, and Rustic finishes, VYARA Cobbles combine aesthetics with practicality. Our team is ready to assist with patterns and special designs, ensuring a perfect fit for your project.



Cobble Square
80/60 mm



Rustic



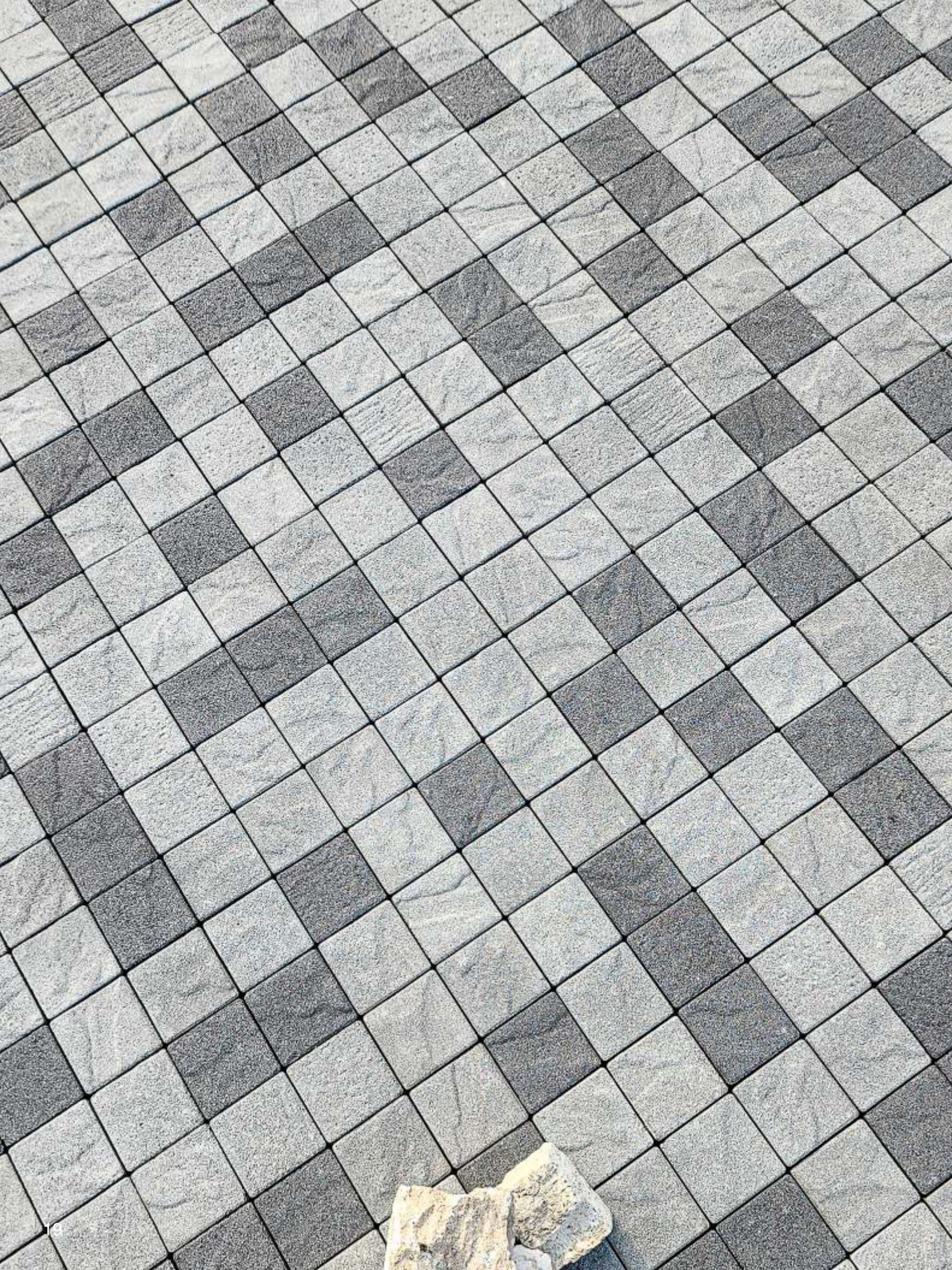

COBBLE SQUARE STONE



VYARA's Cobble Square Stone features 100x100 mm concrete cobbles with a random stone surface texture, offering a natural, non-repetitive appearance that closely resembles real stone. The varied surface textures add an authentic charm, making them virtually indistinguishable from the natural cobbles.

Customisable in a wide range of colours and finishes, these stone textured cobbles combines durability with a timeless, natural aesthetic.



Cobble Square Stone
80/60 mm



COBBLE FAN

VYARA pioneered the first wedge-shaped fan cobble stones in India with its innovative Cobble Fan design, which create visually striking fan, circular, and radial patterns, adding strong graphic appeal and artistic value to landscapes.

Perfect for creating distinctive hardscapes, Cobble Fan combines functionality with aesthetic charm.

Proper planning is essential, as laying patterns and custom key stones vary with each project. Share your drawings with us, and our team will assist in optimizing your design and ensuring flawless installation.



Cobble Fan
60 mm

Rustic Cobble Fan
60 mm





COMBI COBBLES



VYARA's Combi Cobbles allow you to mix and match standalone cobbles, pavers, and flagstones, thanks to their modular sizes. Seamlessly combine different sizes and colours to create subtle or bold graphic patterns, adding a creative and artistic touch to any space while ensuring functionality and versatility.

Finishes available
 Shotblasted | Coated | Rustic

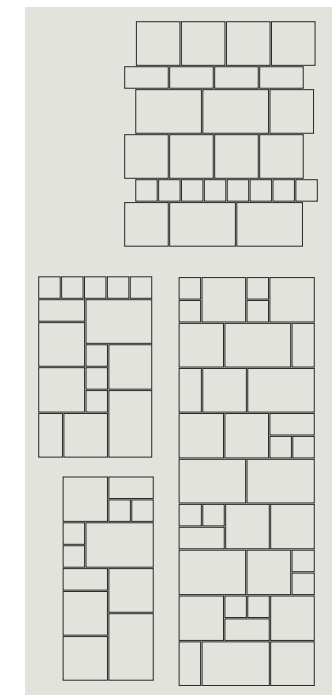

Design options



Cobble Square
 100*100*80/60 mm



Brick
 200*100*80/60 mm



Square
 200*200*80/60 mm



Big Brick
 300*200*80/60 mm



MaxiPave Terracotta

MAXIPAVERTM

VYARA's MaxiPave is a durable, eco-friendly paving solution for pedestrian walkways, cycling tracks, and urban areas. Featuring modular flags in three sizes, including the largest at 750x375 mm, MaxiPave allows **quick, adhesive-free installation on sand or aggregate beds**.

Its rounded and conical spacers enhance interlocking, reduce maintenance, and improve drainage, making it ideal for areas with mobility aids. Perfect for urban precincts, public gardens, and recreational spaces, MaxiPave provides clean, hardwearing surfaces with excellent water drainage.



MaxiPave Jetblack and White

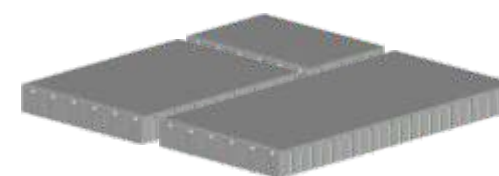

MaxiPave
65 mm



MaxiPave Grey, Black and White



ESCALON™

Escalon is India's first plank paving with a unique concept of varied-size paving planks. Comprising 16 stones in 9 sizes, the largest being 600x150 mm and 560x120 mm, all 100 mm thick.

The carefully chosen thickness, the specially designed combination interlocking spacer bars, the lack of chamfer in the stones, are some of the special features that make the Escalon unique. It is a true pragmatic, quick and inexpensive, yet top end plank format paving. It is ideal for light vehicular traffic and occasional heavy loads.

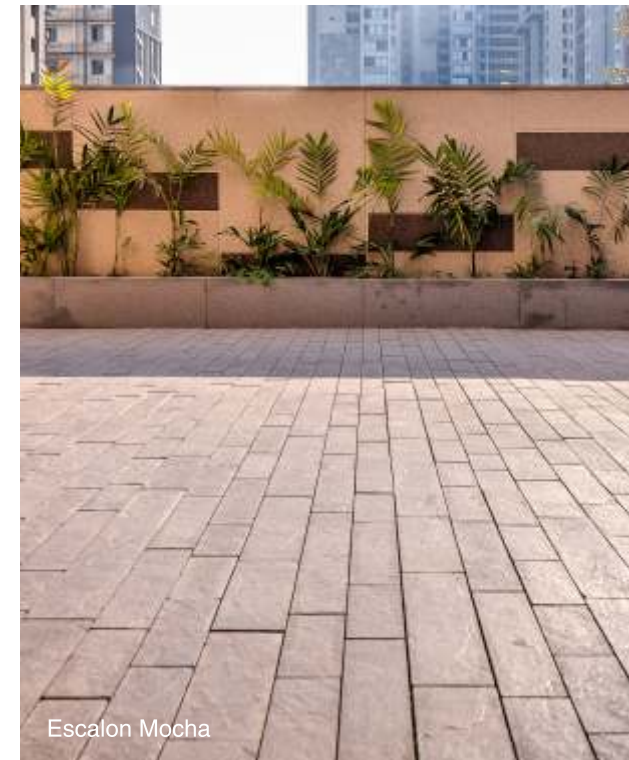

Escalon Mocha

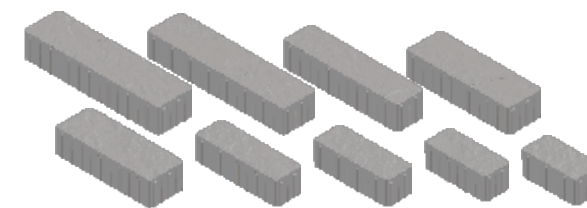

Escalon
100 mm



Escalon Jetblack and Grey



OMKAR
2

DECASTONE™

VYARA's Decastone offers rugged, stone-like durability with an 80 mm thickness. Featuring ten modules, the largest at 225x220 mm, they enable versatile paving patterns.

With unique spacers for superior interlocking, Decastone is ideal for internal roads, driveways, and gated communities. Its undulating surface mimics aged cobbles without the maintenance challenges, and finishes include Plain, Shotblasted and Mélange.



Decastone Grey and Orange



Decastone Jetblack and Orange



Decastone
80 mm

Decastone Grey and Orange



Decastone Neo Grey and Black

DECASTONETM NEO

VYARA's Decastone Neo Pavers enhance the Decastone range with a subtle, even texture that is easier to clean, maintain, and pedestrian friendly. Designed at 80 mm thickness, they feature ten stone sizes for versatile, visually appealing patterns and strong interlocking.

Ideal for internal roads, driveways, and high-traffic areas in residential and commercial spaces, Decastone Neo delivers the durability, style, and performance of a stone-like surface without the maintenance challenges. Available in Shotblasted, PremierShield and Mélange finishes.



Decastone Neo



Decastone Neo Grey

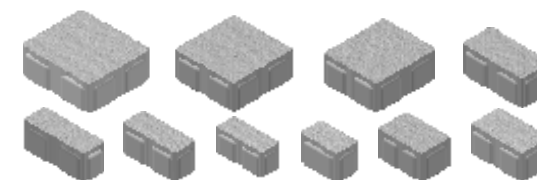

Decastone Neo
80 mm



RUSTICO™

VYARA's Rustico Paving, the first in India with an embossed surface and grooved edges for additional edge protection, features a beautiful slate texture and has demonstrated proven performance for over a decade.

Perfect for residential and commercial hardscaping, including internal roads and light traffic areas, Rustico also offers customizable Mélange options for a distinctive finish.



Rustico Jet Black



Rustico
70 mm



Rustico Coffee Bean



BEGANITTM NEO

VYARA's Beganit Neo pavers build on the legacy of India's first wedge-shaped, chamfer-free cobble setts, introduced in 2006. With enhanced features like a cleaner, more usable surface and reduced edge damage, Beganit Neo offers a refined, rock-like texture that balances aesthetics with practicality.

Ideal for internal roads, residential landscapes, and hardscaped spaces, these 60 mm thick pavers provide a tough yet timeless stone finish, delivering durability and sophistication for any outdoor setting.

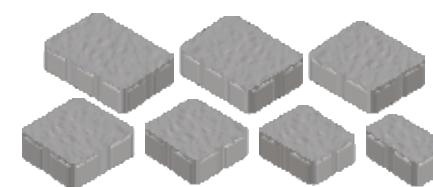
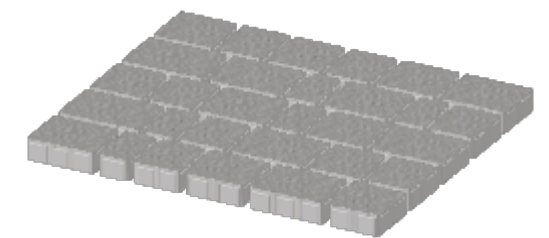

Beganit Neo
60 mm



Brick Maple

MÉLANGE

VYARA's Mélange series, launched in 2010, introduced colour-blended concrete pavers that combine premium aesthetics with reliable performance. Inspired by global paving traditions, Mélange offers a sophisticated, natural look with consistent quality and repeatable processes.

Mélange finish is available in the following designs

Beganit Neo | Brick | Cobble Square | Decastone | Decastone Neo | Escalon | MaxiPave | Quadrastein | Quadrastein Stona | Rustico

and in the following blend options



Autumn



Coffee Bean



Maple



Nubra



Rains



Terracotta



MÉLANGE

All Mélangé products feature **PremierShield Protection** for enhanced durability, water and oil repellence, UV resistance, and vibrant color retention. Suitable for large-scale projects, Mélangé elevates any landscape.



Cobble Terracotta



Rustico Coffee Bean



PAVER FINISHES



Shotblasted

Shotblasting is a VYARA forte. VYARA maintains an edge over the competition in quality, supply, and range of Shotblasted paving. Shotblasting is ideal for texturing and efflorescence removal from concrete products.

PremierShield

PremierShield is a premium, integral, and topcoat treatment system for paving materials. It enhances water and oil repellence, prevents efflorescence, algae, and moss, and offers UV-stable, long-lasting protection with vibrant color enhancement which increases the value of the paving.



Rustic

VYARA's Rustic Tumbled Pavers, first in India, deliver an antique, weathered look through controlled distressing. Ideal for driveways, garden paths, and patios, they combine timeless charm, slip resistance, and durability. Optional shotblasting or PremierShield coating further enhances their beauty and performance.



FLAGSTONES



VYARA's Flagstones are large-format concrete pavers, ideal for urban spaces, pedestrian areas, and light vehicular traffic. Available in sizes up to 600x300 mm and thicknesses of 60 mm or 80 mm, they offer durability and slip resistance.

Available in various finish options hence combining the look of natural stone with enhanced performance.

Modular combinations with smaller pavers add design versatility.

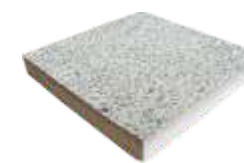

300*300*80/60 mm



400*400*80/60 mm



300*450*80/60 mm



300*600*120/100/80/60 mm

FLAGSTONES

Our seamlessly modular Flagstones can be paired with smaller paving units, unlocking a variety of innovative design possibilities. These combinations enable striking layouts that balance functionality and aesthetics, with several pre-designed options available for immediate use to enhance your project.

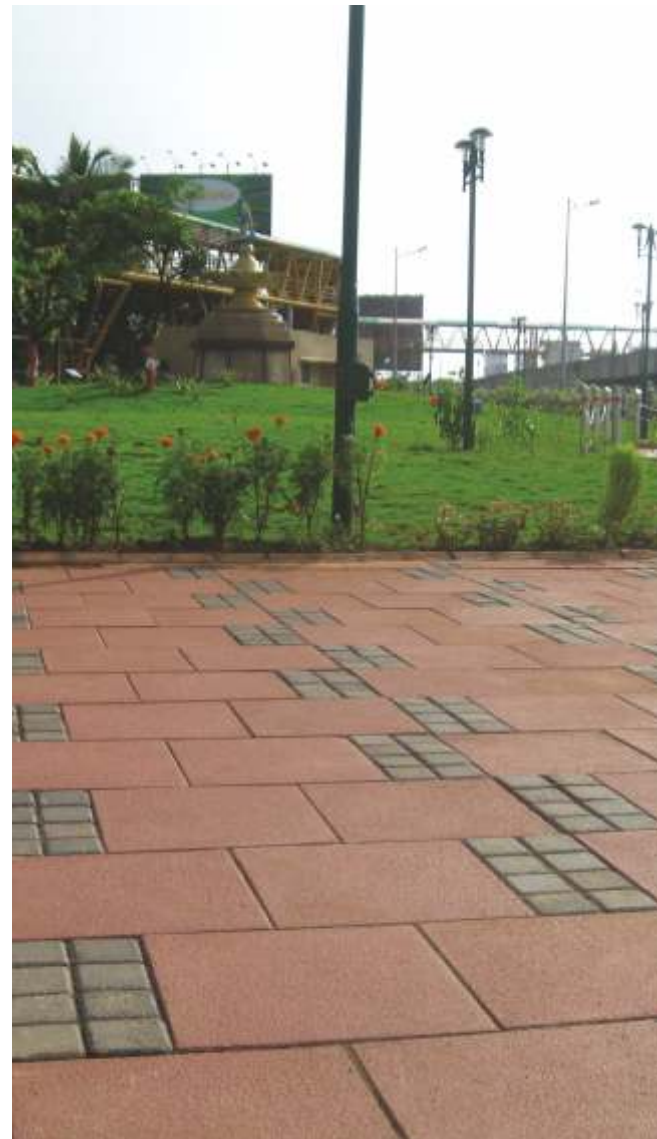

Applications

Concrete flag paving provides an attractive surface suitable for:

- Pedestrian footways and precincts
- Forecourts and entrances to public buildings
- Approaches and surrounds to residential and industrial buildings
- Areas surrounding shops and offices
- School playgrounds
- Public and private gardens
- Swimming pool surrounds
- Footways where vehicular overrun is unavoidable
- Home zones and urban regeneration
- And other areas where a durable external surface is required

PLAIN FLAGS

Timeless Concrete Elegance



SHOTBLASTED FLAGS

Durable Micro-Exposed Surface



HONED FLAGS

Semi-Polished Perfection



GRANNAMEXX FLAGS

Granite Like Durability for High Pedestrian Traffic Areas

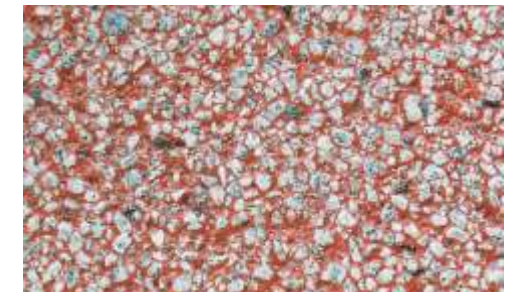

WASHBETON FLAGS

Natural Beauty with Exposed Aggregates



TEXTURED FLAGS

Versatile Patterns and Tactile Designs





BELLEZZA

VYARA's Bellezza wet cast pavers offer a glossy lacquer finish, vibrant colors, and refined textures, making them ideal for decorative applications.

With exceptional durability and over 50 color options, they add elegance to driveways, walkways, and outdoor spaces



Rhomba

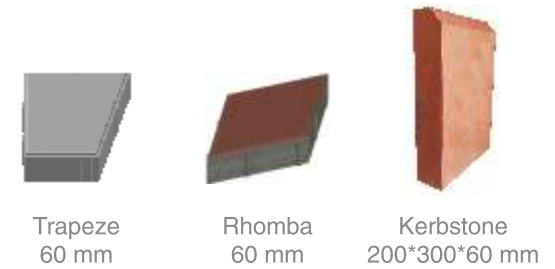

Trapeze
60 mm

Rhomba
60 mm

Kerbstone
200*300*60 mm



Trapeze



Trapeze



BELLEZZA

Bellezza pavers deliver exceptional luster, strength, and luxury, crafted through precise wet casting. They are perfect for creating unique, decorative designs in small to medium-scale projects.



Speedbreaker
380*380*110 mm
Speedbreaker End
380*190*110 mm



Eta
80/60 mm



Square
200*200*60 mm



Rumbler
200*200*75 mm



Eta



Square

KERBSTONES

Pre-cast concrete kerbs are often referred to as the unsung heroes of roads and streets. They serve multiple functions, including:

- Enhancing aesthetics and contributing to the paved environment.
- Strengthening carriageway edges for durability.
- Deterring vehicles from mounting footways, ensuring pedestrian safety.
- Preventing vegetation from encroaching onto roads.

Kerbstones are versatile, suitable for urban roads, footways, medians, playgrounds, pedestrian precincts, and industrial pavements.

VYARA's extensive range of products and accessories enables designers to deliver outstanding and detailed solutions for their clients



VACUUM WET PRESS KERBS

VYARA pioneered the introduction of a comprehensive range of kerbs in India, manufactured using the vacuum wet press process. This method combines high hydraulic pressure and simultaneous vacuuming, resulting in kerbs with exceptional finish and durability, ideal for road applications. If specified, these kerbs can meet the stringent technical standards of EN 1340: 2003 and IS 5758: 2020.

Characteristics of Wetpress Kerbs	Benefits
Very high strength	Long life and value retention of the project. Vehicles can climb over
Large sizes	Fewer joints and better looks
Extremely good finish	Better aesthetics
High abrasion resistance	Lower need for repair and replacement
Low water absorption	Much reduced erosion and maintenance of kerbs
Extremely wide range of products	Allows for most of the details to be catered to

There are four basic profiles commonly used for road kerbs:

- **Half Batter (HB)**- Most frequently used shape, for deflection of traffic and safety of pedestrians
- **Splay (SP)**- Allows vehicles to climb over the footway.
- **Bull Nose (BN)**- Provides smooth access for vehicles crossing from road to entry points.
- **Square (SQ)**- Provides smooth access for vehicles crossing from road to entry points.

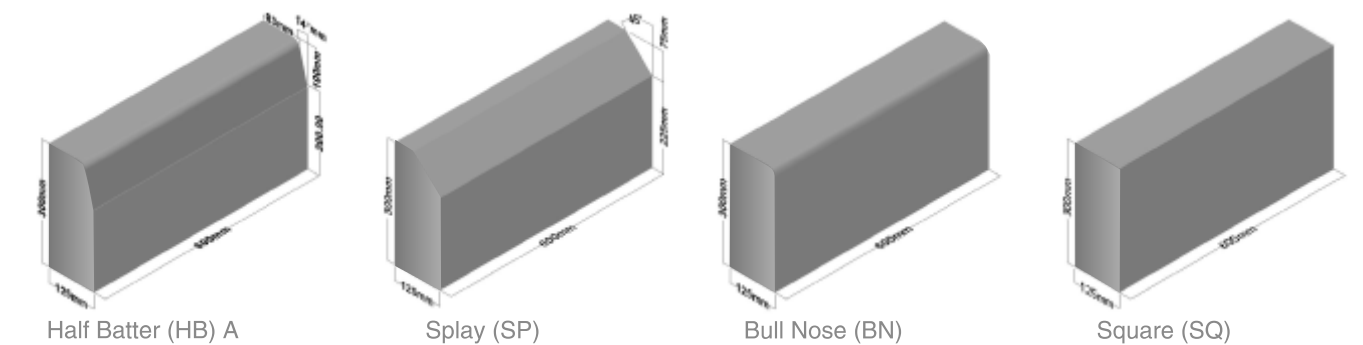

Profile	Length (mm)	Height (mm)	Thickness (mm)
Half Batter (HB) A	1000	300	100
Half Batter (HB) A	600	450/375/300/215/175	150/125/100
Half Batter (HB) A	300	600	150/125/100
Half Batter (HB) B	500	325	165/150
Splay (SP)	600	450/375/300	150/125
Bull Nose (BN)	600	450/375/300/215/175	150/125/100
Bull Nose (BN)	600	300	65/80
Square (SQ)	600	450/375/300	150/125/100

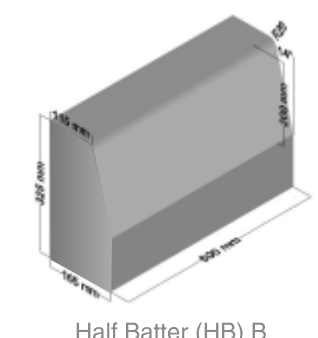

*Please refer to our Kerbstones brochure for the full range

ACCESSORY KERBS



Accessory Kerbs facilitate transitions between kerb types, footway drops, and accommodate radiuses and turnings in roads, ensuring detailed design solutions.

- Transition Kerbs
- Dropper Kerbs
- Radius Kerbs
- Quadrant Kerbs
- Angle Kerbs
- Offlet Kerbs
- Dished Channel
- Sloped Channel
- Gully Kerbs
- L Profiled Kerbs (HB and BN)

These when used together, offer a fairly complete solution to the kerbing needs, whether in the neighborhood, streets or in highways.

*Please refer to our Kerbstones brochure for the full range.

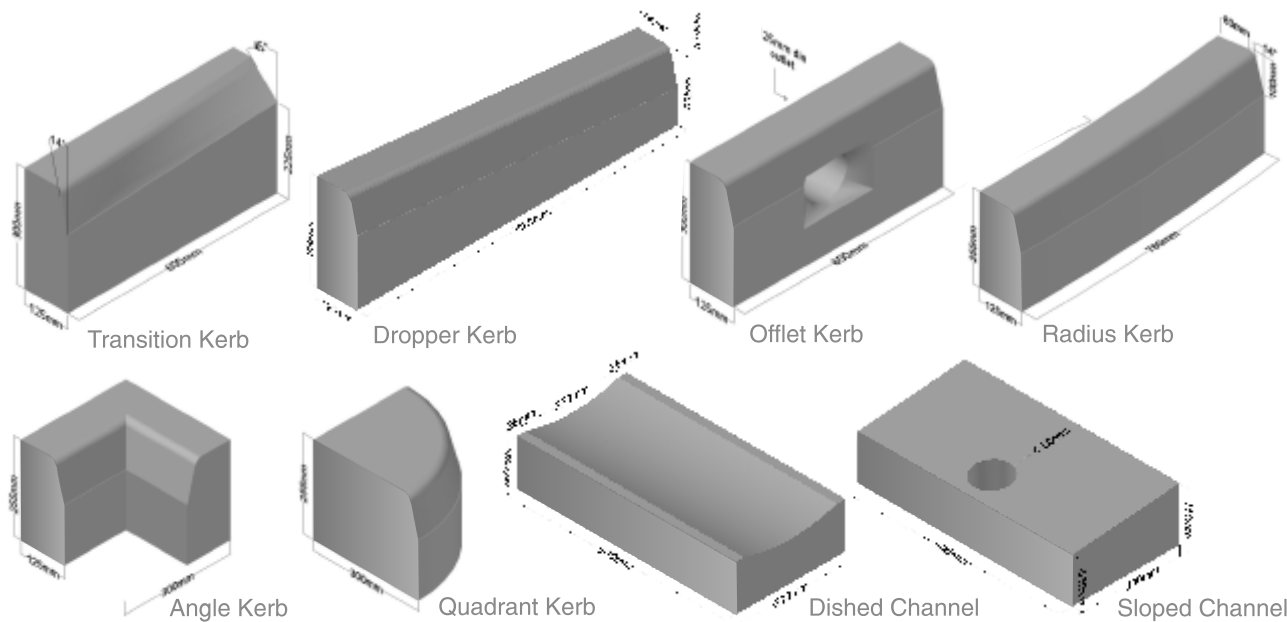

ETCETERA



Etcetera by VYARA is a growing range of precast solutions designed for unique applications. Available in plain or reinforced options, these products come in matching colours and textures to suit varied needs.

TREE GUARD



Tree Guard TG-2
800*800*75 mm, ID 500 mm



Tree Guard TG-3
950*950*75 mm, ID 650 mm

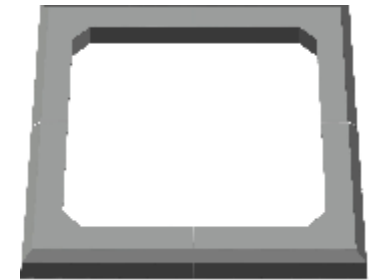

Tree Guard TG-4
900*900*100 mm, INL 700 mm

DRAIN COVER



Drain Cover
900*600*100 mm
600*450*100/80 mm



Drain Cover
940*300*100 mm
700*300*100/60 mm

BOLLARD

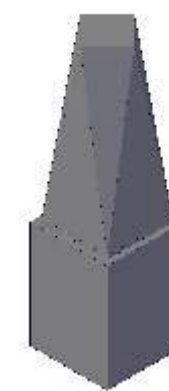

Bollard
250*250*900 mm

TRENCHSTONE

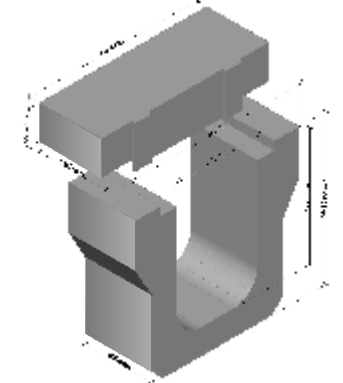

TrenchStone
490*450*200 mm
Trenchcover
490*200*125 mm

HOLLOW & SOLID BLOCKS

High Quality Concrete Hollow and Solid blocks as per requirements of IS 2185 can be supplied in bulk.

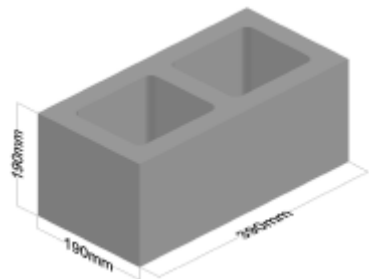

Hollow 200
390*190*190mm

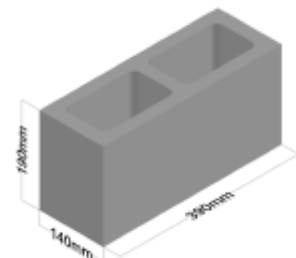

Hollow 150
390*190*140mm

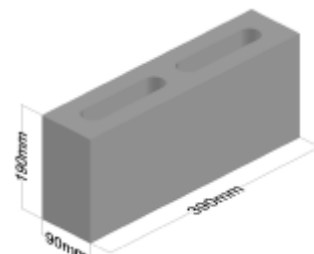

Hollow 100
390*190*90mm

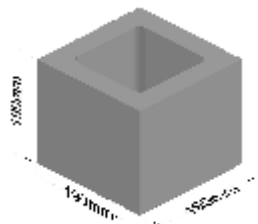

Hollow 200 Half
190*190*190mm

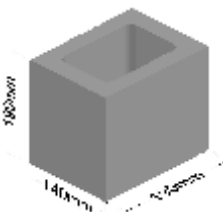

Hollow 150 Half
190*190*140mm

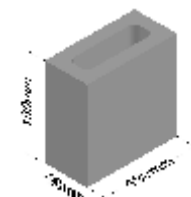

Hollow 100 Half
190*190*90mm

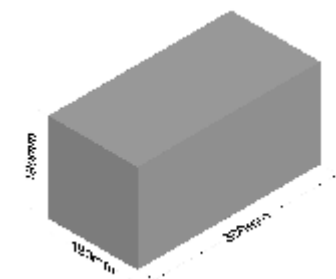

Solid 200
390*190*190mm

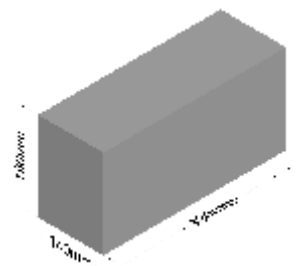

Solid 150
390*190*140mm

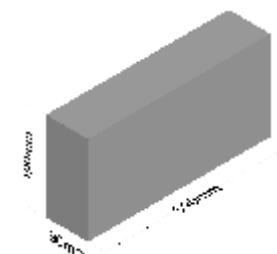

Solid 100
390*190*90mm

OTHER RANGE

VYARA offers an extensive range of products for diverse applications, each thoughtfully designed and refined. Explore our separate brochures for detailed insights into these specialized ranges.

PASSAGIO

A versatile range of concrete tiles for diverse landscaping applications, featuring the premium Peblino Tiles and the classic, timeless Chequered Tiles.



Chequered Tiles

Granamexx Tiles

Shotblasted Tiles

Peblino Tiles

TERRAZZO TILES

A bespoke range of concrete terrazzo tiles, meticulously crafted with an innovative blend of colors, aggregates, patterns, and textures to elevate any space.



Terrazzo Tiles

Galicha Tiles (Motivo)

Industrial & Terrace Tiles

FREEFORM

Discover FREEFORM by VYARA, an exquisite range of fine architectural premixes, designed for cast-on-site finishes that elevate the aesthetics of floors and walls.



Floors

Wall Finishes

Base Materials

Seal & Protect

DIY

DESIGN ENHANCEMENT

Beyond delivering high-quality products tailored to specific applications, VYARA pioneers initiatives that elevate both the functional and aesthetic performance of hardscaped areas.

Design and construction of base

VYARA helps with expert guidance in base design and construction to align with your paving requirements.

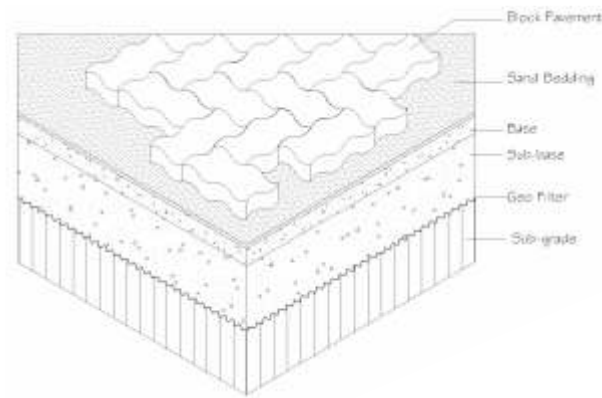

Overall selection of materials, paving designs and layouts

VYARA helps accentuate, scale, and integrate pavements with a project's design legacy, ensuring users feel accommodated.

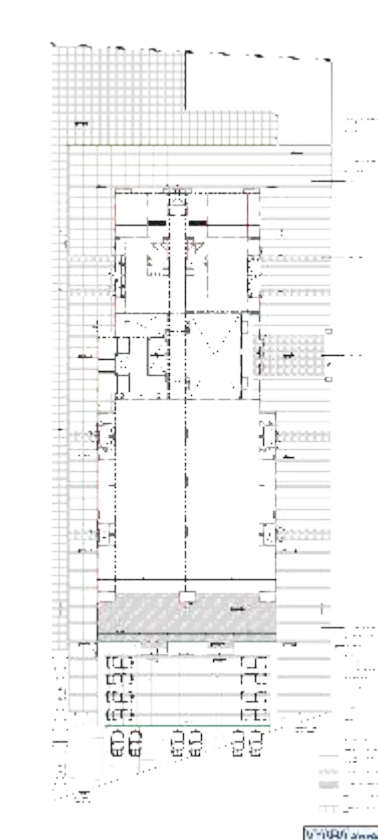

Edge and border detailing

Simple borders, proper detailing of typical features appearing on site like manholes, road turning etc. and making the correct type of 'cut-ins' greatly enhance the value of the site.

Some simple square and rectangular shapes of stones can be used for effective border details, which largely enhance the pavement.



Cobble Square
100*100*60 mm



Brick
200*100*60 mm



Square
150*150*60 mm
200*200*60 mm

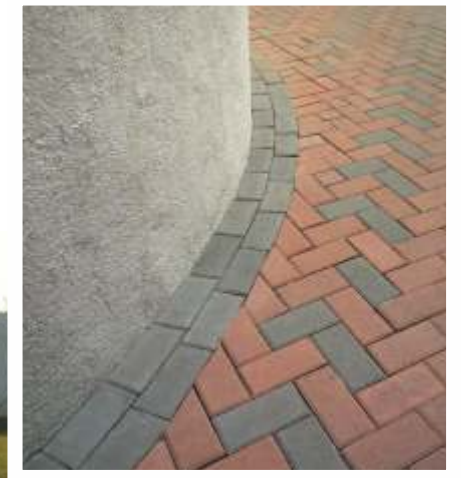

About Us

State-of-the-Art Manufacturing Facilities

World-class manufacturing facilities enable the seamless execution of critical or large-scale projects within demanding timeframes.

Enhanced Quality Planning and Testing

VYARA employs formal quality planning with rigorous QA/QC at every stage—incoming materials, in-process production, and post-production—ensuring consistent quality and reliability in every solution.

Certified Excellence

ISO 9001, ISI, and GreenPro certifications reflect VYARA's commitment to sustainability and world-class standards.

Comprehensive Solution Portfolio

Beyond paving and kerbs, FreeForm provides bespoke architectural solutions, including Terrazzo, Microcement, and Stonecrete, offering tailored and innovative solutions for residential and commercial spaces.



Weigh Batching & Mixing



Block Plant



Elevator



Finger Car



Curing Chambers



Dispatch

VYARA Profile

- Since 1968
- Strong customer orientation
- Great company to work with and work for
- Several nationwide firsts in products and finishes
- Promise to improve the site experience at every site



VYARA Testing Lab

Sustainability initiatives at VYARA

- GreenPro Certification
- Generous use of SCMs
- 100% Solar Power installation (at date of printing)
- Water saving and recycling initiatives
- Option of Cement free GeoPolymer concrete blocks under UNCARBON range
- Tight process controls and high durability of products contribute to lower LC costs



www.vyaratiles.in



Surat Office (HO): Vyara Tiles Limited
903-904 Rajhans Montessa, Nr. Le Meridian,
Dumas Road, Surat 395007, Gujarat
0261-2472444, 9327447469 | info@vyaratiles.in

Ahmedabad Office: Vyara Tiles Limited
1317-1318, Block B, Navratna Corporate Office
Ambli Bopal Road, Ahmedabad 380058, Gujarat
9374034284, 6357322771 | ahmedabad@vyaratiles.in

Bharuch Office: Vyara Tiles Limited
FF2 RK Avenue, Zadeshwar Crossing to Shuklirth Road,
Bharuch 392011, Gujarat
9375568855 | bharuch@vyaratiles.in

Mumbai Office: Vyara Tiles Limited
61, Discovery Complex, Dattapadda Road,
Borivali (E), Mumbai 400066, Maharashtra
022-28544404, 9322285672 | mumbai@vyaratiles.in

Vadodara Office: Vyara Tiles Limited
15, Silver Coin Complex, Nr. Shrenik Park Char Rasta,
Akota, Vadodara 390020, Gujarat
9376979755 | vadodara@vyaratiles.in

Vapi Office: Vyara Tiles Limited
105, Anmol Complex, NH 48, Nr. GEB Office,
Balitha, Vapi 396191, Gujarat
9377575856 | vapi@vyaratiles.in

Pavers | Flagstones | Cobbles | Kerbstones | Tiles



FM 702712

