

Specifications for Concrete Cobble Square 80mm thick – Melange Series with Premier Shield protection (Integral and top coat treatment)

Supply of Solid Concrete Cobble Square Melage Series of VYARA make, - in colours specified by the architects.

- in 2-3 color blends, as indicated in picture below, colours as specified by architects using UV resistant color pigments from Lanxess.
- wear resistant color coordinated aggregates.
- Premier Shield integral and topcoat treatment for satin finish, water and oil repellence, reduction of algae, moss and efflorescence formation.
- Size 97*97*80 mm thick. Nominal size of 100mm *100mm.

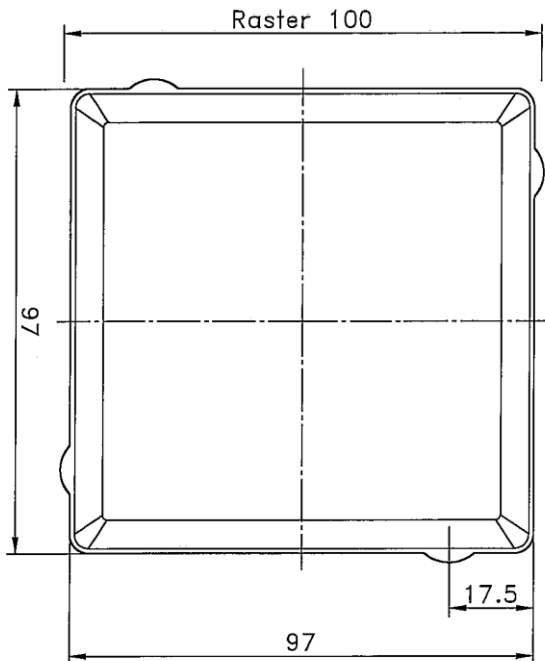

Sr.	Parameters	Minimum Requirements
1.	Percentage Water Absorption	Average not over 6%
2.	Compressive strength	Average not less than 300 Kg/cm ²
3.	Tensile Splitting Strength (as per EN 1338)	Average not less than 3.6Mpa
4.	Average wear in Thickness-Abrasion	Conforming to Grade 'H' of EN 1338
5.	Tolerance in size (length + breadth)	±1.5mm
6.	Thickness of wearing layer	Not less than 5mm
7.	Tolerance in Thickness of block	±3mm
8.	Colours	UV Light resistant fast colours from Lanxess only to be used

- The Concrete Cobble must be manufactured on Vibropress type machine only. The manufacturer must demonstrate the feeding of material into the machines by automatic batching plants with capacity of min 30 m³/hr.
- The manufacturing company must be an ISO 9001:2015 certified Company or should have equivalent quality management systems in place to ensure quality product.
- The Concrete Cobble must meet the sustainability criteria and should be certified as a green product by CII.
- The Concrete Cobble will be made using wear resistant materials in the face mix as specified by the architects.
- The colours of the Concrete Cobble (wearing layer) will be as selected by the architects.
- The Concrete Cobble must be cured in a controlled environment to ensure efflorescence free material.
- The manufacturer must have in house testing laboratory to carry out all testing including Compressive strength testing, Water absorption, abrasion resistance etc.